



BURNERS

baltur **75** 
Energy for People 1950 - 2025



TBML 200 MC



TBML 200 ME

TBML 200 MC

TBML 200 ME

Alternating natural gas/light oil burner according to european regulation EN676 and EN267. Two-stage progressive operation on gas, two-stage on light oil

mechanical two-stage progressive/two-stage

Alternating natural gas/light oil burner according to european regulation EN676 and EN267. Modulating operation on gas, two-stage on light oil

modulating electronic/two-stage

	TBML 200 MC	TBML 200 ME
P.I.D. controller and signal receiver (0÷10V / 4÷20 mA) integrated in burner control panel	○	●
Modulation ratio:	1:4	1:4
Burner with Low NOx and CO emissions on gas according to European standard EN676:	class 2	class 2
Burner with Low NOx and CO emissions on light oil according to European standard EN267:	class 2	class 2
Adjusting the combustion head	●	●
Maintenance facilitated by the possibility of removing the mixing unit and combustion head without having to remove the burner from the boiler	●	●
High ventilation efficiency, low electrical input, low noise	●	●
Sliding boiler coupling flange to adapt the blast-pipe to the various types of boilers	●	●
Easy maintenance thanks to the two-sides hinge which allows the removal of the combustion head without having to remove the burner from the boiler	●	●
Combustion air intake with butterfly valve. Air flow adjustment:	mechanical cam	electric servomotor
Fully closing air damper on shutdown to avoid loss of heat through the chimney	●	●
Combustion air intake designed to achieve optimum linearity of the air gate opening	●	●
CE version gas train is complete with operation and safety valve with electromagnetic drive, valve tightness control, minimum pressure switch, pressure regulator and gas filter	●	●
Fail proof connectors for burner/gas train connection	●	●
Gas train outlet:	up	up
Pump connected to fan motor through electromagnetic clutch	●	●
Fuel supply circuit made of gear pump with pressure adjustment, shut-off valves and safety valve	●	●
Fuel switch device:	manual	manual
Flame detection by UV photocell	●	●
Control panel with display diagram for working mode with indication lights	●	
Control panel equipped either with display showing the working process and with the keyboard for the burner adjustment		●
Electric protection rating:	IP40	IP40

LEGEND:

○ Optional, ● As standard

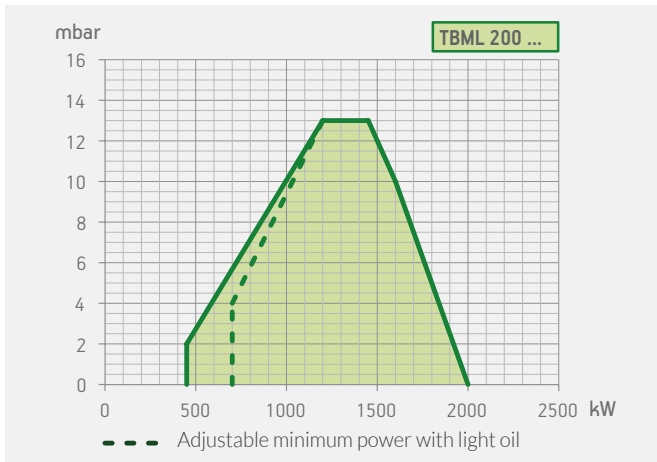

Model	Size of packaging			Weight kg
	L	P	H	
TBML 200 MC	1070	800	700	103
TBML 200 ME	1070	800	700	108

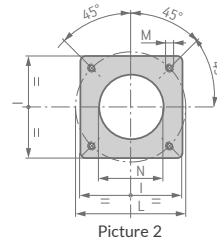

Flange dimensions and boiler drilling template.

TBML 200 MC

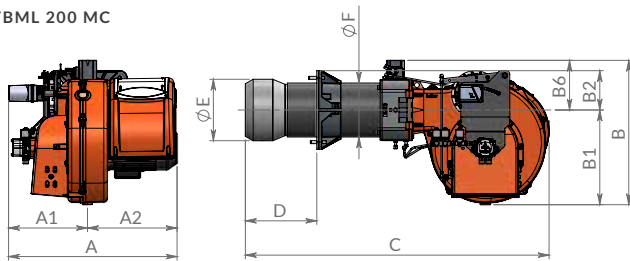

TBML 200 ME

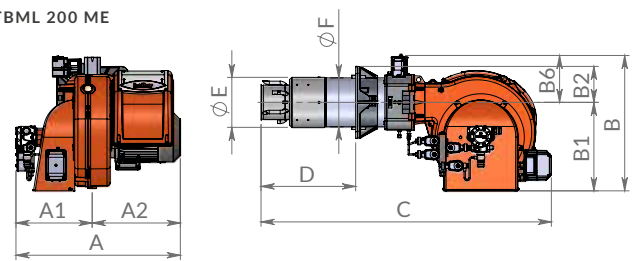

Model	A mm	A1 mm	A2 mm	B mm	B1 mm	B2 mm	B6 mm	C mm	D mm	E mm	F mm	I mm	L mm	M	N mm	Pic.
TBML 200 MC	700	330	370	580	380	200	200	1270	300 ÷ 470	250	219	320	300 ÷ 370	M12	255	2
TBML 200 ME	700	330	370	580	380	200	200	1270	300 ÷ 470	250	219	320	300 ÷ 370	M12	255	2

	Emissions class	Thermal output kW	Model	Part no.	Max visc. °E at 20°C	Electrical supply	Motor kW	Note
Frequency 50 Hz								
	class 2	450(700)* ÷ 2000	TBML 200 MC	56610010	1,5	3N AC 50Hz 400V	3,0	4)
	class 2	450(700)* ÷ 2000	TBML 200 ME	56620010	1,5	3N AC 50Hz 400V	3,0	4)
Frequency 60 Hz								
	class 2	450(700)* ÷ 2000	TBML 200 MC	56615410	1,5	3N AC 60Hz 380V	3,5	4)
	class 2	450(700)* ÷ 2000	TBML 200 ME	56625410	1,5	3N AC 60Hz 380V	3,5	4)

TO COMPLETE THE BURNER

DESCRIPTION
TBML 200 ME: modulating probe for LCM 100 (see page 6)

MODULATING MODE

DESCRIPTION	PART NO.
TBML 200 MC: modulation kit	98000057
TBML 200 MC: modulating probe (see page 6)	

NOTE

4 Equipped with automatic air closure device.
 *) Min thermal capacity with light oil operation.
 Net calorific value:
 Natural gas: Hi = 35,80 MJ/m³ = 8550 kcal/m³ at reference conditions of 0°C, 1013mbar.
 LPG: Hi = 92 MJ/m³ = 22000 kcal/m³, at reference conditions 0°C, 1013mbar.
 Light oil: Hi = 42,70 MJ/kg = 10200 kcal/kg.
 For different type of gas and pressure values, please get in contact with our commercial department.

ACCESSORIES AVAILABLE ON REQUEST

DESCRIPTION	PART NO.
Soundproof burner cover (see page 11)	97980053

BURNER ACCESSORIES

TBML 200 MC: line filter, flex hoses, nozzles, boiler coupling kit, plug for wiring
TBML 200 ME: line filter, flex hoses, nozzles, boiler coupling kit.

BURNER/GAS TRAIN MATCH

DUAL FUEL
GAS/LIGHT OIL BURNERS

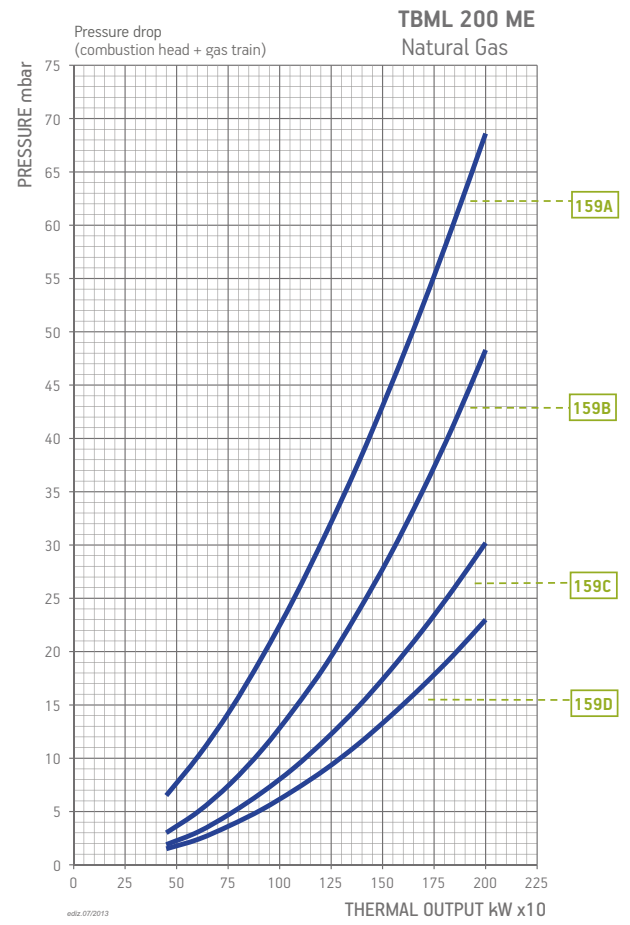
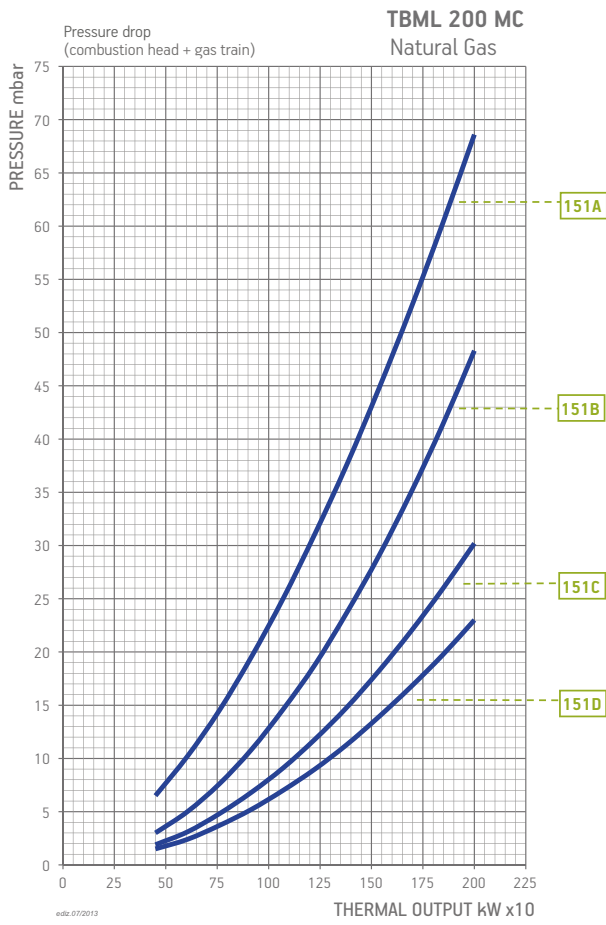

BURNER/GAS TRAIN MATCH

Burner model	Gas type	Curve on graph	Version	P.Max ** mbar	Execution	Gas train	Regulator with incorporated filter	Burner/gas train adapter	Valve tightness control kit	Pic.	Note
						Part no.	Part no.	Part no.	Part no.		
TBML 200 MC	Natural gas	151A	CE/EXP	360	CTV	19990583	Included	-	Included	D7	
		151B	CE/EXP	500	CTV	19990584	Included	-	Included	D7	
		151C	CE/EXP	500	CTV	19990585	Included	-	Included	D7	
		151D	CE/EXP	500	CTV	19990586	Included	-	Included	D7	
TBML 200 ME	Natural gas	159A	CE/EXP	360	CTV	19990559	Included	-	Included	D2	
		159B	CE/EXP	500	CTV	19990524	Included	-	Included	D2	
			CE/EXP	500	CTV	19990725	Included	-	Included	D4	
		159C	CE/EXP	500	CTV	19990525	Included	-	Included	D2	
			CE/EXP	500	CTV	19990726	Included	-	Included	D4	
		159D	CE/EXP	500	CTV	19990526	Included	-	Included	D2	
			CE/EXP	500	CTV	19990727	Included	-	Included	D4	

Burner model	Gas type	Version	P.Max ** mbar	Execution	Gas train	Regulator with incorporated filter	Burner/gas train adapter	Valve tightness control kit	Pic.	Note
					Part no.	Part no.	Part no.	Part no.		
TBML 200 MC	LPG	CE/EXP	360	CTV	19990583	Included	-	Included	D7	
TBML 200 ME	LPG	CE/EXP	360	CTV	19990559	Included	-	Included	D2	

To choose the correct gas train please refer to the information on page 17 of the Burners Catalogue.

For information on the structure, composition, and size of the gas train please refer to the diagrams on page 12.

NOTE

CTV Gas train with Valve Tightness Control.

**) Maximum gas inlet pressure at pressure regulator.

MODULATION

The two stage progressive burners, by installing the PID load controller and related modulating kit, can operate as modulating burners with the ability to adjust the thermic load according to boiler needs. The load adjustment is possible between the minimum and maximum burner's operating point.

How to choose the modulating kit components:

According to the parameter that it's necessary to control: temperature (°C) or pressure (bar) it's necessary to choose the range kit according to boiler operating range.

In case the value is included in two ranges it's necessary to select the lower range.

Example:

In case the required hot water boiler set point is 100°C it's necessary to select the temperature probe kit with operating range between 0 ÷ 130°C.

In case the steam boiler must operate with 8bar outlet steam pressure it's necessary to select the pressure probe kit with operating range between 0 ÷ 10 bar.



Automatic proportional modulation regulator PID

Part no.	Kit	Burners
98000055	Modulation kit LC3	TBG 450 ÷ 2000 MC
98000056	Modulation kit LC3	TBG 35 MC
98000057	Modulation kit LC3	TBML 80 ÷ 360 MC
98000058	Modulation kit LC3	TBG 45 ÷ 60 MC
98000059	Modulation kit LCM 100	ME models
98000065	Modulation kit LC4	TBG 80 ÷ 360 MC

Temperature probe for LC3 modulation

Part no.	Temperature	Type robe	Probe length	Male coupling
98000023	0 °C ÷ 130 °C	PT 1000	85 ¹⁾	R 1/2"
98000021	0 °C ÷ 500 °C	PT 1000	200 ¹⁾	G 1/2"
98000022	0 °C ÷ 1100 °C	Thermocouple	425 ¹⁾	R 1/2"

Temperature probe for LCM 100 modulation

Part no.	Temperature	Type robe	Probe length	Male coupling
98000023	0 °C ÷ 130 °C	PT 1000	85 ¹⁾	R 1/2"
98000021	0 °C ÷ 500 °C	PT 1000	200 ¹⁾	G 1/2"

Temperature probe for ETAMATIC OEM control box

Part no.	Temperature	Type robe	Probe length	Male coupling
98000035	0 °C ÷ 500 °C	PT 100	100 ¹⁾	G 1/2"

Steam pressure probe (for all types of automatic regulator)*

Part no.	Pressure steam	Signal output	Male coupling
98000045	0 ÷ 1 bar	4 ÷ 20 mA	G 1/2"
98000046	0 ÷ 10 bar	4 ÷ 20 mA	G 1/2"
98000047	0 ÷ 16 bar	4 ÷ 20 mA	G 1/2"
98000048	0 ÷ 25 bar	4 ÷ 20 mA	G 1/2"
98000049	0 ÷ 40 bar	4 ÷ 20 mA	G 1/2"

*) In the case of using applications where temperatures exceed 90°C you need to match the kit codes: 98000062

NOTE: In combination with the LC4 modulation kit for MC models, a 12V power supply kit is mandatory.

98000482	12V power supply kit
----------	----------------------

External climate regulation

Part no.	Description	Temperature
85060070	Temperature probe PT100	-50 °C ÷ 90 °C
98000061	Interface module for LC3	

Power signal converter (TBG 45÷360 MC / LX MC)

Part no.	Description
98000063	Converter kit 0 ÷ 10V / 4 ÷ 20 mA

UV safe kit

Part no.	Description
98000443	UV SAFE KIT TBG 80-360 FGR
98000444	UV SAFE KIT TBG 450-750 FGR
98000445	UV SAFE KIT TBG 800 FGR
98000446	UV SAFE KIT TBG 1200 FGR

Note: For different modulation values please contact our Technical Assistance Service.

1) Different lengths on request.

RETURN NOZZLES

Nozzle with fuel return for diesel and mixed series two-stage progressive / modulating and modulating burners. This kind of nozzle, while keeping the pump pressure constant, varies the amount of

fuel supplied according to the return pressure of the nozzle. To be ordered together with the burner when placing the order according to the power required by the application.

Nozzles for light oil (ratio 1÷3) excluded burners: TBML 800

Part no.	Rated flow-rate kg/h	Flow-rate angle	Part no.	Rated flow-rate kg/h	Flow-rate angle
98000201	50	45°	98000218	400	45°
98000202	60	45°	98000219	425	45°
98000203	70	45°	98000220	450	45°
98000204	80	45°	98000221	475	45°
98000205	90	45°	98000222	500	45°
98000206	100	45°	98000223	525	45°
98000207	125	45°	98000224	550	45°
98000208	150	45°	98000225	575	45°
98000209	175	45°	98000226	600	45°
98000210	200	45°	98000227	650	45°
98000211	225	45°	98000228	700	45°
98000212	250	45°	98000229	750	45°
98000213	275	45°	98000230	800	45°
98000214	300	45°	98000231	850	45°
98000215	325	45°	98000232	900	45°
98000216	350	45°	98000233	1000	45°
98000217	375	45°			



Nozzles for light oil (ratio 1÷4) for burners TBML 450÷900 - TBL 450÷750 - TBL 1000

Part no.	Rated flow-rate kg/h	Flow-rate angle	Part no.	Rated flow-rate kg/h	Flow-rate angle
98000264	200	45°	98000277	550	45°
98000265	225	45°	98000278	600	45°
98000266	250	45°	98000279	650	45°
98000267	275	45°	98000271	700	45°
98000268	300	45°	98000273	750	45°
98000269	330	45°	98000276	800	45°
98000270	360	45°	98000286	800	50°
98000272	400	45°	98000287	850	50°
98000274	450	45°	98000288	900	50°
98000275	500	45°			



Nozzles for light oil (ratio 1÷5) for burners TBML 800 - TBL 1000

Part no.	Rated flow-rate kg/h	Flow-rate angle	Part no.	Rated flow-rate kg/h	Flow-rate angle
98000238	200	45°	98000249	475	45°
98000239	225	45°	98000250	500	45°
98000240	250	45°	98000251	525	45°
98000241	275	45°	98000252	550	45°
98000242	300	45°	98000253	575	45°
98000243	325	45°	98000254	600	45°
98000244	350	45°	98000255	650	45°
98000245	375	45°	98000256	700	45°
98000246	400	45°	98000257	750	45°
98000247	425	45°	98000258	800	45°
98000248	450	45°	98000259	850	45°
			98000260	900	45°



Nozzles for heavy oil (ratio 1÷5) - Type W4

Part no.	Rated flow-rate kg/h	Flow-rate angle	Part no.	Rated flow-rate kg/h	Flow-rate angle
98000500	300	45°	98000508	500	45°
98000501	325	45°	98000509	525	45°
98000502	350	45°	98000510	550	45°
98000503	375	45°	98000511	600	45°
98000504	400	45°	98000512	650	45°
98000505	425	45°	98000513	700	45°
98000506	450	45°	98000514	750	45°
98000507	475	45°			

Gas pressure regulator with incorporated filter approved CE*

Control closing , pressure taps upstream side - the side valley , safety diaphragm.
Max inlet pressure : 1 bar.

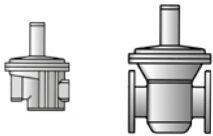

Part no.	Model	Outlet pressure mbar	Gas connection
97392010	BTFR/1	40 ÷ 110	1/2"
97392020	BTFR/1	40 ÷ 110	3/4"
97392030	BTFR/1	40 ÷ 110	1"
97392040	BTFR/1	90 ÷ 190	1"1/4
97392050	BTFR/1	90 ÷ 190	1"1/2
97392060	BTFR/1	90 ÷ 190	2"
97392070	BTFR/1	110 ÷ 200	DN65 - PN16
97392080	BTFR/1	110 ÷ 200	DN80 - PN16
97392090	BTFR/1	130 ÷ 200	DN100 - PN16

CE gas pressure regulator CE*

Control closing , pressure taps upstream side - the side valley , safety diaphragm.
Max inlet pressure : 1 bar.

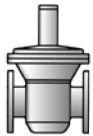

Part no.	Model	Outlet pressure mbar	Gas connection
97392100	BTR/1	100 ÷ 250	DN125 - PN16
97392110	BTR/1	100 ÷ 250	DN150 - PN16

Gas pressure regulator with incorporated filter approved CE*

Control closing , pressure taps upstream side - the side valley , safety diaphragm.
Max inlet pressure : 2 bar.

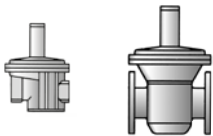

Part no.	Model	Outlet pressure mbar	Gas connection
97392210	BTFR/2	40 ÷ 110	1/2"
97392220	BTFR/2	40 ÷ 110	3/4"
97392230	BTFR/2	40 ÷ 110	1"
97392240	BTFR/2	90 ÷ 190	1"1/4
97392250	BTFR/2	90 ÷ 190	1"1/2
97392260	BTFR/2	90 ÷ 190	2"
97392270	BTFR/2	110 ÷ 200	DN65 - PN16
97392280	BTFR/2	110 ÷ 200	DN80 - PN16
97392290	BTFR/2	130 ÷ 200	DN100 - PN16

Gas pressure regulator with incorporated filter approved CE*

Control closing , pressure taps upstream side - the side valley , safety diaphragm.
Max inlet pressure : 6 bar.

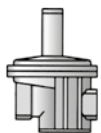

Part no.	Model	Outlet pressure mbar	Gas connection
97392310	BTFR/6	30 ÷ 90	1/2"
97392320	BTFR/6	30 ÷ 90	3/4"
97392330	BTFR/6	30 ÷ 90	1"

CE gas pressure regulator CE*

Control closing , pressure taps upstream side - the side valley , safety diaphragm.
Max inlet pressure : 6 bar.

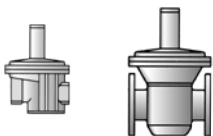

Part no.	Model	Outlet pressure mbar	Gas connection
97392340	BTR/6	85 ÷ 180	1"1/4
97392350	BTR/6	85 ÷ 180	1"1/2
97392360	BTR/6	85 ÷ 180	2"
97392370	BTR/6	110 ÷ 200	DN65 - PN16
97392380	BTR/6	110 ÷ 200	DN80 - PN16
97392390	BTR/6	110 ÷ 200	DN100 - PN16

*) All the pressure regulators in these pages have a standard spring with its own adjustment field For different delivery pressures, the able below shows the regulation field that must be used, as well as the corresponding spring to replace the standard one with.

ACCESSORIES FOR CONNECTION OF BURNERS TO GAS MAINS

PRESSURE REGULATOR SPRINGS

		1/2"	3/4"	1"	1"1/4	1"1/2	2"	DN 65	DN 80	DN 100	DN 125	DN 150							
PRESSURE INPUT 1bar	regulator code	97392010	97392020	97392030	97392040	97392050	97392060	97392070	97392080	97392090	97392100	97392110							
	code spring	97399002	97399005	97399007	97399008	97399009	97399010	97399011	97399012	97399013	97399014	97399015	97399016	97399017	97399018	97399019	97399020	97399021	97399022
		9 ÷ 28	9 ÷ 28	9 ÷ 28															
		18 ÷ 40	18 ÷ 40	18 ÷ 40															
					13 ÷ 23	13 ÷ 23	13 ÷ 23												
		40 ÷ 110*	40 ÷ 110*	40 ÷ 110*															
					20 ÷ 36	20 ÷ 36	20 ÷ 36												
		110 ÷ 150	110 ÷ 150	110 ÷ 150															
		150 ÷ 200	150 ÷ 200	150 ÷ 200	33 ÷ 58	33 ÷ 58	33 ÷ 58												
					55 ÷ 100	55 ÷ 100	55 ÷ 100												
									13 ÷ 27	13 ÷ 27	15 ÷ 27								
									22 ÷ 50	22 ÷ 50	22 ÷ 55								
		200 ÷ 600	200 ÷ 600	200 ÷ 600															
					90 ÷ 190*	90 ÷ 190*	90 ÷ 190*												
									50 ÷ 130	50 ÷ 130	55 ÷ 130								
								110 ÷ 200*	110 ÷ 200*	130 ÷ 200*									
											20 ÷ 150	20 ÷ 150							
											100 ÷ 250*	100 ÷ 250*							
											230 ÷ 350	230 ÷ 350							
											300 ÷ 450	300 ÷ 450							
PRESSURE INPUT 2 bar	regulator code	97392210	97392220	97392230	97392240	97392250	97392260	97392270	97392280	97392290									
	code spring	97399001	97399005	97399008	97399010	97399011	97399012	97399013	97399014	97399015	97399016	97399017	97399018						
		9 ÷ 22	9 ÷ 22	9 ÷ 22															
		20 ÷ 40	20 ÷ 40	20 ÷ 40															
		40 ÷ 110*	40 ÷ 110*	40 ÷ 110*	12 ÷ 35	12 ÷ 35	12 ÷ 35												
		110 ÷ 150	110 ÷ 150	110 ÷ 150	30 ÷ 50	30 ÷ 50	30 ÷ 50												
		150 ÷ 200	150 ÷ 200	150 ÷ 200	40 ÷ 60	40 ÷ 60	40 ÷ 60												
					60 ÷ 95	60 ÷ 95	60 ÷ 95												
									13 ÷ 27	13 ÷ 27	15 ÷ 27								
									22 ÷ 50	22 ÷ 50	27 ÷ 55								
	200 ÷ 600	200 ÷ 600	200 ÷ 600																
				90 ÷ 190*	90 ÷ 190*	90 ÷ 190*													
								50 ÷ 130	50 ÷ 130	55 ÷ 130									
								110 ÷ 200*	110 ÷ 200*	130 ÷ 200*									
PRESSURE INPUT 6 bar	regulator code	97392310	97392320	97392330	97392340	97382350	97392360	97392370	97392380	97392390									
	code spring	97399003	97399004	97399006	97399009	97399011	97399012	97399013	97399014	97399016	97399017	97399018							
		20 ÷ 30	20 ÷ 30	20 ÷ 30															
		30 ÷ 90*	30 ÷ 90*	30 ÷ 90*															
		90 ÷ 170	90 ÷ 170	90 ÷ 170															
					15 ÷ 33	15 ÷ 33	15 ÷ 33												
					32 ÷ 60	32 ÷ 60	32 ÷ 60												
					50 ÷ 95	50 ÷ 95	50 ÷ 95												
									13 ÷ 27	13 ÷ 27	13 ÷ 22								
									22 ÷ 58	22 ÷ 58	18 ÷ 40								
				85 ÷ 180*	85 ÷ 180*	85 ÷ 180*													
								50 ÷ 130	50 ÷ 130	25 ÷ 120									
								110 ÷ 200*	110 ÷ 200*	110 ÷ 200*									

*) of series.

ACCESSORIES FOR CONNECTION OF BURNERS TO GAS MAINS

Gas filters approved CE

With pressure.

Max inlet pressure: 2 bar.

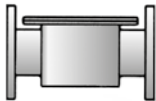

Part no.	Model	Gas connection
97410001	BTF	1/2" FF
97410002	BTF	3/4" FF
97410003	BTF	1" FF
97410004	BTF	1" 1/4 FF
97410005	BTF	1" 1/2 FF
97410006	BTF	2" FF
97419999	BTF	DN65 - PN16
97429999	BTF	DN80 - PN16
97439999	BTF	DN100 - PN16
97459999	BTF	DN125 - PN16
97449999	BTF	DN150 - PN16

Gas filters approved CE

With pressure.

Max inlet pressure: 6 bar.

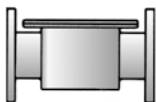

Part no.	Model	Gas connection
97410010	BTF/6	1" 1/4" FF
97410011	BTF/6	1" 1/2" FF
97410012	BTF/6	2" FF
97410013	BTF/6	DN65 - PN16
97410014	BTF/6	DN80 - PN16
97410015	BTF/6	DN100 - PN16

Anti-vibration and compensation joints approved CE

DIN 30681 stainless steel.

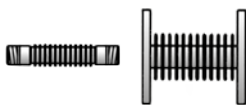

Part no.	Model	Gas connection
97029999	BTGA	1/2" MM
97039999	BTGA	3/4" MM
97049999	BTGA	1" MM
97059999	BTGA	1" 1/4" MM
97069999	BTGA	1" 1/2" MM
97079999	BTGA	2" MM
97089999	BTGA	DN65 - PN16
97099999	BTGA	DN80 - PN16
97109999	BTGA	DN100 - PN16
97119999	BTGA	DN125 - PN16
97129999	BTGA	DN150 - PN16

Ball valves approved CE

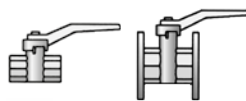

Part no.	Model	Gas connection
97679999	BTVS	3/8" FF
97689999	BTVS	1/2" FF
97699999	BTVS	3/4" FF
97709999	BTVS	1" FF
97719999	BTVS	1" 1/4" FF
97729999	BTVS	1" 1/2" FF
97739999	BTVS	2" FF
97749999	BTVS	DN65 - PN16
97759999	BTVS	DN80 - PN16
97769999	BTVS	DN100 - PN16
97179999	BTVS	DN125 - PN16
97189999	BTVS	DN150 - PN16

SOUNDPROOF BURNER

Average sound pressure reduction of about 10 dB(A) measured in a laboratory with 1 meter microphone from the burner.

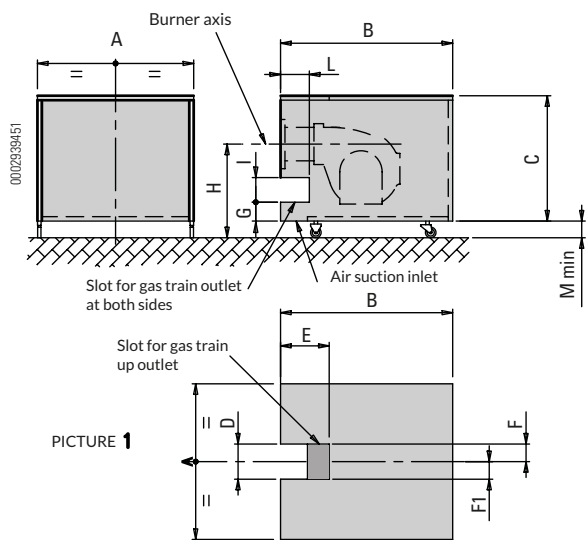

PICTURE 1

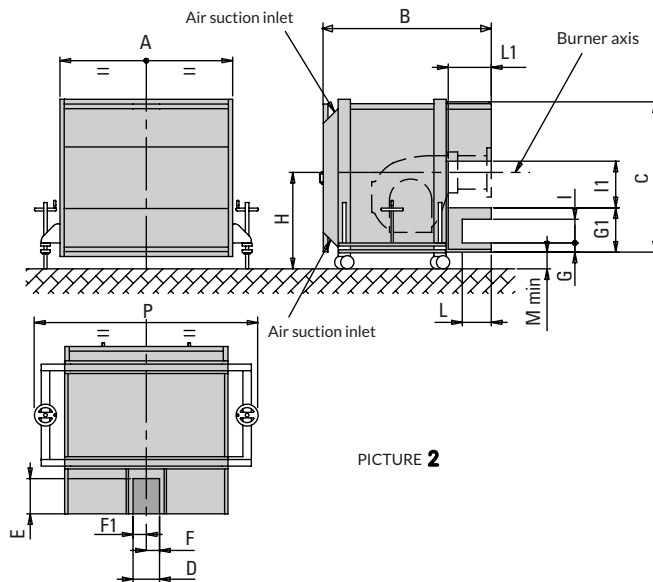

PICTURE 2

Model	Sound pressure	Pic.	A	B	C	D	E	F	F1	G	G1	H mm		I	I1	L	L1	M min	P
			mm	mm	mm	mm	mm	mm	mm	mm	mm	mm	mm	min	max	mm	mm	mm	mm
97980053*	-10 dB(A)	1	1100	1340	860	85	500	42,5	42,5	207	-	660	1350	85	-	500	-	190	-
97980054	-10 dB(A)	1	750	1080	650	85	380	42,5	42,5	157	-	560	1060	85	-	355	-	190	-
97980055	-10 dB(A)	1	1100	1340	860	85	440	42,5	42,5	-	-	650	1300	-	-	-	-	190	-
97980057	-10 dB(A)	1	1335	1655	1130	210	495	47,5	162,5	-	-	900	1700	-	-	-	-	190	-
97980058*	-10 dB(A)	1	1610	1740	1190	500	380	37,5	462,5	24,5	-	950	1700	210	-	380	-	190	-
97980059	-20 dB(A)	1	1560	1645	1190	500	380	37,5	462,5	245	-	950	1700	210	-	380	-	190	-
97980061	-20 dB(A)	2	1956	1945	1740	300	400	150	150	104	504	1450	1700	270	530	330	490	180	2540
97980063	-20 dB(A)	2	2180	1950	1830	350	410	175	175	85	480	1400	1200	310	580	345	505	195	2765

Note:

For gas burners in case of gas train up outlet it is necessary to install a 200 mm long cilindric extension.

*) To decrease the sound pressure by 20 dB(A) please contact our sales office.

ATTENTION:

It's customer responsibility to check the correct matching of soundproof according to the height of the boiler.

GAS TRAIN STRUCTURE AND COMPOSITION

D2

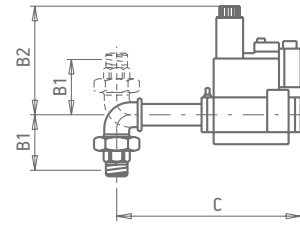
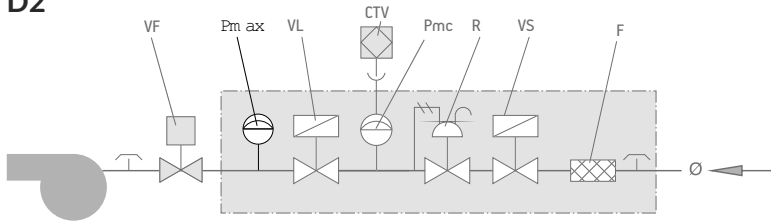

Gas train Part no.	Position									Gas train dimensions mm			Size of packaging mm L x P x H	Weight kg	
	CTV	F	Pmax	Pmc	R	VF	VL	VS	Ø	B1	B2	C			
19990524 (VGD20.503)	●	●		●	●	◆	●	●	●	2"	114	285	890	990 x 300 x 500	14
19990525 (VGD40.065)	●	●		●	●	◆	●	●	●	DN65	114	320	1120	1380 x 430 x 700	26
19990526 (VGD40.080)	●	●		●	●	◆	●	●	●	DN80	114	325	1175	1380 x 430 x 700	28
19990555 (MB...407)	●	●		●	●	◆	●	●	●	3/4"	72	140	350	300 x 210 x 300	5
19990556 (MB...410)	●	●		●	●	◆	●	●	●	1"1/4	95	160	390	300 x 210 x 300	8
19990557 (MB...412)	●	●		●	●	◆	●	●	●	1"1/4	95	160	390	300 x 210 x 300	8
19990558 (MB...415)	●	●		●	●	◆	●	●	●	1"1/2	103	170	490	460 x 250 x 460	11
19990559 (MB...420)	●	●		●	●	◆	●	●	●	2"	114	220	520	520 x 410 x 410	13
19990561 (MB...415)	●	●		●	●	◆	●	●	●	1"1/2	103	170	490	520 x 410 x 410	11
19990562 (MB...420)	●	●		●	●	◆	●	●	●	2"	114	220	520	520 x 410 x 410	13
19990573 (MB...407)	●	●		●	●	3/4"	●	●	●	3/4"	72	160	305	400 x 300 x 280	12
19990574 (MB...410)	●	●		●	●	3/4"	●	●	●	1"1/4	95	160	355	400 x 300 x 280	15
19990575 (MB...412)	●	●		●	●	3/4"	●	●	●	1"1/4	95	160	355	400 x 300 x 280	15
19990576 (MB...415)	●	●		●	●	3/4"	●	●	●	1"1/2	103	170	445	520 x 410 x 410	18
19990577 (VGD40.065)	●	●		●	●	◆	●	●	●	DN65	125	320	760	1030 x 430 x 650	50
19990578 (VGD40.080)	●	●		●	●	◆	●	●	●	DN80	175	325	860	1030 x 430 x 650	57
19990748 (MB...412)	●	●	●	●	●	◆	●	●	●	1"1/4	95	160	410	520 x 410 x 410	8
19990749 (MB...415)	●	●	●	●	●	◆	●	●	●	1"1/2	103	170	500	520 x 410 x 410	11
19990750 (MB...420)	●	●	●	●	●	◆	●	●	●	2"	114	220	500	520 x 410 x 410	13
19990754 (MB...415)	●	●	●	●	●	◆	●	●	●	1"1/2	103	170	500	520 x 410 x 410	11
19990755 (MB...420)	●	●	●	●	●	◆	●	●	●	2"	114	220	500	520 x 410 x 410	13

D7

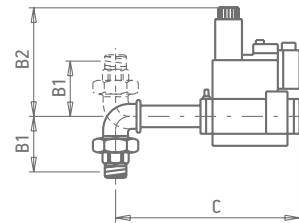
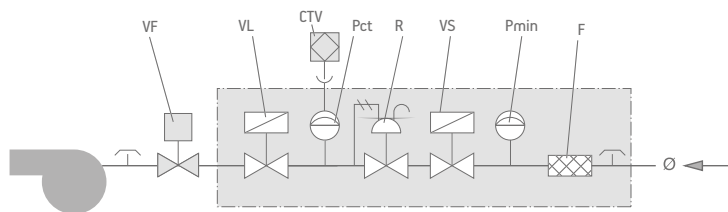

Gas train Part no.	Position									Gas train dimensions mm			Size of packaging mm L x P x H	Weight kg
	CTV	F	Pct	Pmin	R	VF	VL	VS	Ø	B1	B2	C		
19990580 (MB...410 - 1")	●	●	●	●	●	◆	●	●	1"1/4	95	160	390	300 x 210 x 300	8
19990581 (MB...412 - 1"1/4)	●	●	●	●	●	◆	●	●	1"1/4	95	160	390	300 x 210 x 300	8
19990582 (MB...415 - 1"1/2)	●	●	●	●	●	◆	●	●	1"1/2	103	170	490	460 x 250 x 460	11
19990583 (MB...420 - 2")	●	●	●	●	●	◆	●	●	2"	114	220	520	520 x 410 x 410	13
19990584 (VGD20.503 - 2")	●	●	●	●	●	◆	●	●	2"	114	285	890	990 x 300 x 500	15
19990585 (VGD40.065 - 2"1/2)	●	●	●	●	●	◆	●	●	DN65	114	320	1120	1380 x 430 x 700	26
19990586 (VGD40.080 - 3")	●	●	●	●	●	◆	●	●	DN80	114	325	1190	1380 x 430 x 700	28
19990624 (MB...420 - 2")	●	●	●	●	●	◆	●	●	2"	114	220	520	520 x 410 x 410	13

GAS TRAIN STRUCTURE AND COMPOSITION

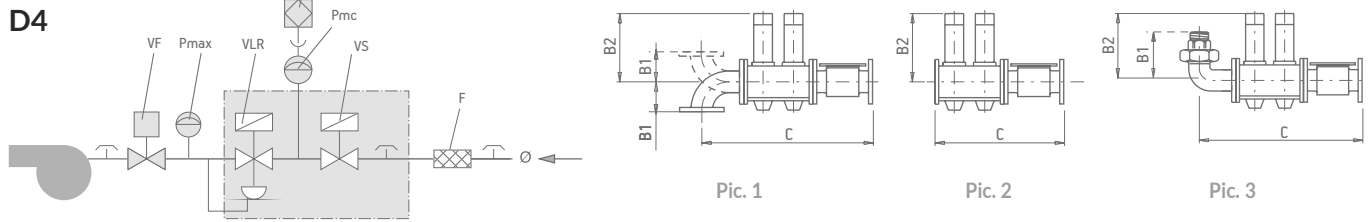

Gas train Part no.	Position								Gas train dimensions mm			Size of packaging mm	Weight kg	Pic.
	CTV	F	Pmax	Pmc	VF	VLR	VS	Ø	B1	B2	C	L x P x H		
19990541 (VGD20.503 - 2")	●	2"	●	●	◆	●	●	2"	145	285	890	990 x 300 x 500	23	1
19990542 (VGD40.065 - 2"1/2)	●	DN65	●	●	◆	●	●	DN65	135	320	970	1380 x 430 x 700	36	1
19990543 (VGD40.080 - 3")	●	DN80	●	●	◆	●	●	DN80	135	325	1010	1380 x 430 x 700	38	1
19990544 (VGD40.100 - 4")	●	DN100	●	●	◆	●	●	DN100	175	330	1100	1380 x 430 x 700	44	1
19990588 (VGD40.065 - 2"1/2)	●	DN65	●	●	◆	●	●	DN65	-	320	580	830 x 430 x 640	26	2
19990589 (VGD40.080 - 3")	●	DN80	●	●	◆	●	●	DN80	-	325	630	830 x 430 x 640	29	2
19990590 (VGD40.100 - 4")	●	DN100	●	●	◆	●	●	DN100	-	330	730	830 x 430 x 640	40	2
19990606 (VGD40.080 - 3")	●	DN80	●	●	◆	●	●	DN80	165	325	1015	1380 x 430 x 700	38	1
19990607 (VGD40.100 - 4")	●	DN100	●	●	◆	●	●	DN100	175	330	1100	1380 x 430 x 700	44	1
19990608 (VGD40.125 - 5")	●	DN125	●	●	◆	●	●	DN125	170	350	1275	1580 x 430 x 720	60	1
19990618 (VGD40.100 - 4")	●	DN100	●	●	◆	●	●	DN100	200	330	1260	1380 x 430 x 710	45	1
19990619 (VGD40.125 - 5")	●	DN125	●	●	◆	●	●	DN125	209	350	1410	1580 x 430 x 740	83	1
19990620 (VGD40.150 - 6")	●	DN150	●	●	◆	●	●	DN150	200	370	1490	1580 x 430 x 740	95	1
19990626 (VGD40.150 - 6")	●	DN150	●	●	◆	●	●	DN150	170	370	1280	1580 x 430 x 720	95	1
19990633 (VGD40.080)	●	DN80	●	●	◆	●	●	DN80	132	314	1006	1380 x 430 x 600	17	1
19990634 (VGD40.100)	●	DN100	●	●	◆	●	●	DN100	163	331	1096	1380 x 430 x 610	30	1
19990640 (VGD40.100 - 4")	●	DN100	●	●	◆	●	●	DN100	175	330	1100	1380 x 430 x 700	44	1
19990641 (VGD40.125 - 5")	●	DN125	●	●	◆	●	●	DN125	170	350	1275	1580 x 430 x 720	60	1
19990648 (VGD40.100 - 4")	●	DN100	●	●	◆	●	●	DN100	200	330	1260	1380 x 430 x 710	45	1
19990649 (VGD40.125 - 5")	●	DN125	●	●	◆	●	●	DN125	207	350	1312	1580 x 430 x 740	83	1
19990650 (VGD40.150 - 6")	●	DN150	●	●	◆	●	●	DN150	200	370	1485	1580 x 430 x 740	95	1
19990666 (VGD20.065 - 2"1/2)	●	DN65	●	●	◆	●	●	DN65	135	285	1120	1380 x 430 x 700	45	1
19990674 (VGD40.125)	●	DN125	●	●	◆	●	●	DN125	163	349	1173	1580 x 430 x 630	42	1
19990679 (MBE 050)	●	2"	●	●	◆	●	●	2"	135	311	880	990 x 300 x 500	22	1
19990680 (MBE 065)	●	DN65	●	●	◆	●	●	DN65	105	380	970	1380 x 430 x 700	38	1
19990681 (MBE 080)	●	DN80	●	●	◆	●	●	DN80	105	380	1005	1380 x 430 x 700	40	1
19990682 (MBE 100)	●	DN100	●	●	◆	●	●	DN100	110	380	1100	1380 x 430 x 700	45	1
19990683 (MBE 080)	●	DN80	●	●	◆	●	●	DN80	105	380	1005	1380 x 430 x 700	40	1
19990684 (MBE 100)	●	DN100	●	●	◆	●	●	DN100	110	380	1100	1380 x 430 x 700	45	1
19990685 (MBE 125)	●	DN125	●	●	◆	●	●	DN125	130	380	1175	1580 x 430 x 720	58	1
19990686 (MBE 080)	●	DN80	●	●	◆	●	●	DN80	105	380	1015	1370 x 420 x 710	47	1
19990687 (MBE 100)	●	DN100	●	●	◆	●	●	DN100	110	380	1100	1380 x 430 x 700	55	1
19990688 (MBE 125)	●	DN125	●	●	◆	●	●	DN125	128	380	1280	1580 x 430 x 720	58	1
19990689 (MBE 100)	●	DN100	●	●	◆	●	●	DN100	110	380	1135	1380 x 430 x 710	46	1
19990690 (MBE 125)	●	DN125	●	●	◆	●	●	DN125	128	380	1285	1580 x 430 x 740	81	1
19990691 (MBE 150)	●	DN150	●	●	◆	●	●	DN150	142	380	1355	1580 x 430 x 740	93	1
19990725 (MBE 050)	●	2"	●	●	◆	●	●	2"	99	311	878	990 x 300 x 500	13	3
19990726 (MBE 065)	●	DN65	●	●	◆	●	●	DN65	105	380	1118	1380 x 430 x 700	28	3
19990727 (MBE 080)	●	DN80	●	●	◆	●	●	DN80	105	380	1190	1380 x 430 x 700	30	3
19990728 (MBE 065)	●	DN65	●	●	◆	●	●	DN65	125	380	760	1030 x 430 x 650	52	1
19990729 (MBE 080)	●	DN80	●	●	◆	●	●	DN80	105	380	850	1030 x 430 x 650	59	1
19990743 (MBE 065)	●	DN65	●	●	◆	●	●	DN65	105	380	582	830 x 430 x 640	28	1
19990744 (MBE 080)	●	DN80	●	●	◆	●	●	DN80	105	380	622	830 x 430 x 640	31	1
19990745 (MBE 100)	●	DN100	●	●	◆	●	●	DN100	105	380	702	830 x 430 x 640	41	1
19990751 (VGD20.050)	●	2"	●	●	◆	●	●	2"	114	255	890	990 x 300 x 500	14	3
19990752 (VGD40.065)	●	DN65	●	●	◆	●	●	DN65	114	318	1090	1380 x 430 x 700	26	3
19990753 (VGD40.080)	●	DN80	●	●	◆	●	●	DN80	114	325	1175	1380 x 430 x 700	28	3

CTV Valve tightness control.
 F Filter.
 LDU LDU valve tightness control.
 Pct Pressure switch for gas control.
 Pmax Maximum pressure switch.
 Pmc Minimum and control pressure switch gas leaks.
 Pmin Minimum pressure switch.
 R Pressure regulator.
 RF Pressure regulator with filter.

RFP Pressure regulator with filter for pilot gas train.
 RM Manual flow rate regulator.
 RP Pneumatic regulator.
 VF Regulator throttle valve.
 VL Operating valve.
 VL2 Two-stage operating valve.
 VLP Operating pilot valve.
 VLR Operating valve with pressure regulator.

VP Pilot valve.
 VPS VPS valve tightness control.
 VS Safety valve.
 VSP Safety pilot valve.
 Ø Gas train diameter.
 Ø1 Main gas train diameter.
 Ø2 Pilot gas train diameter.

● As Standard.
 ▲ As standard for burners with an output of more than 1200 kW, on request for burners with an output of less than 1200 kW.
 ■ On request.
 ◆ Mounted on burner.



baltur **75** 
Energy for People
www.baltur.com
1950 - 2025

Baltur S.p.A.
Via Ferrarese, 10
44042 Cento (FE) - Italy
Tel. +39 051 684.37.11
info@baltur.it

Quality System Certified
UNI-EN ISO 9001 I.C.I.M. n° 202

The data given in this catalogue is to be deemed approximate and therefore not binding; Baltur reserves the right to make any changes without notice.