



baltur **75** 
Energy for People 1950 - 2025



TBG 35



TBG 35 P



TBG 35 MC



TBG 35 ME

	TBG 35	TBG 35 P	TBG 35 MC	TBG 35 ME
Gas burner compliant with European standard EN676. Operation:	single-stage	two-stage	mechanical two-stage progressive	electronic modulation
P.I.D. controller and signal receiver (0÷10V / 4÷20 mA) integrated in burner control panel			○	○
Modulation ratio:			1:5	1:5
Low NOx and CO emissions gas burner according to European standard EN676:	class 3	class 3	class 3	class 3
Adjusting the combustion head	•	•	•	•
Maintenance facilitated by the possibility of removing the mixing unit without having to remove the burner from the boiler	•	•	•	•
Sliding boiler coupling flange to adapt the blast-pipe to the various types of boilers	•	•	•	•
Combustion air intake with butterfly valve. Air flow adjustment:	manual	electric servomotor	mechanical cam	electric servomotor
Fully closing air damper on shutdown to avoid loss of heat through the chimney		•	•	•
CE version gas train is complete with operation and safety valve with electromagnetic drive, minimum pressure switch, pressure regulator and gas filter	•	•	•	
CE version gas train is complete with operation and safety valve with electromagnetic drive, valve tightness control, minimum pressure switch, pressure regulator and gas filter				•
Possibility to add gas train with valve tightness control	•	•	•	
Fail proof connectors for burner/gas train connection	•	•	•	•
Gas train outlet:	up/down	down	down	up/down
Flame detection by ionisation electrode with connector for microamperometer	•	•	•	•
Electric protection rating:	IP40	IP40	IP40	IP40

LEGEND:

○ Optional, • As standard

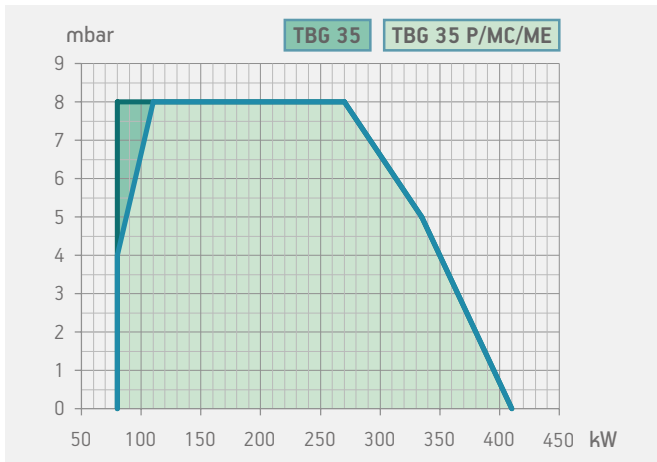

Model	Size of packaging			Weight kg
	L	P	H	
TBG 35	1000	600	510	30
TBG 35 P	1000	600	510	32
TBG 35 MC	1000	600	510	34
TBG 35 ME	1000	600	510	39

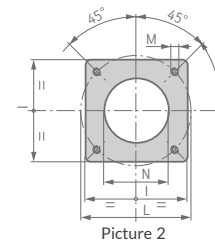
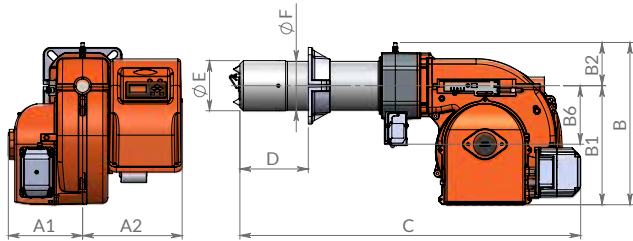

Flange dimensions and boiler drilling template.

Model	A mm	A1 mm	A2 mm	B mm	B1 mm	B2 mm	B6 mm	C mm	D mm	E mm	F mm	I mm	L mm	M	N mm	Pic.
TBG 35	440	210	230	378	270	108	160	860	140 ÷ 300	137	133	215	200 ÷ 245	M12	145	2
TBG 35 P	440	210	230	378	270	108	160	860	140 ÷ 300	137	133	215	200 ÷ 245	M12	145	2
TBG 35 MC	520	290	230	420	270	150	160	860	140 ÷ 300	137	133	215	200 ÷ 245	M12	145	2
TBG 35 ME	465	180	285	377	260	117	160	840	140 ÷ 300	137	133	215	200 ÷ 245	M12	145	2

	Emissions class	Thermal output kW	Model	Part no.	Electrical supply	Motor kW	Note
Frequency 50 Hz							
	class 3	80 ÷ 410	TBG 35	17320010	1N AC 50Hz 230V	0,37	
	class 3	80 ÷ 410	TBG 35 P	17330010	1N AC 50Hz 230V	0,37	4)
	class 3	80 ÷ 410	TBG 35 MC	17360010	1N AC 50Hz 230V	0,37	4)
	class 3	80 ÷ 410	TBG 35 ME	17350010	1N AC 50Hz 230V	0,37	4)
Frequency 60 Hz							
	class 3	80 ÷ 410	TBG 35	17325410	1N AC 60Hz 220V	0,37	
	class 3	80 ÷ 410	TBG 35 P	17335410	1N AC 60Hz 220V	0,37	4)
	class 3	80 ÷ 410	TBG 35 MC	17365410	1N AC 60Hz 220V	0,37	4)
	class 3	80 ÷ 410	TBG 35 ME	17355410	1N AC 60Hz 220V	0,37	4)

MODULATING MODE

DESCRIPTION	PART NO.
TBG 35 MC: modulation kit	98000056
TBG 35 ME: modulation kit	98000059
TBG 35 MC/35 ME: modulating probe (see page 6)	
TBG 35 MC: converter kit 0÷10V / 4÷20 mA	98000063

NOTE

4 Equipped with automatic air closure device.
 Net calorific value at reference conditions of 0°C, 1013mbar:
 Natural gas: Hi = 35,80 MJ/m³ = 8550 kcal/m³,
 LPG: Hi i = 92 MJ/m³ = 22000 kcal/m³.
 For different type of gas and pressure values, please get in contact with our commercial department.

ACCESSORIES AVAILABLE ON REQUEST

DESCRIPTION	PART NO.
Soundproof burner cover (see page 10)	97980054
TBG 35-45 long combustion head L500 NEW 1)	98000457

BURNER ACCESSORIES

TBG 35/35 P/35 MC: boiler coupling kit, plug for wiring
 TBG 35 ME: boiler coupling kit.

N.B.

1) Conversion kit, for standard burner, by installer.
 For supply of the product in long head version, please contact the sales department.

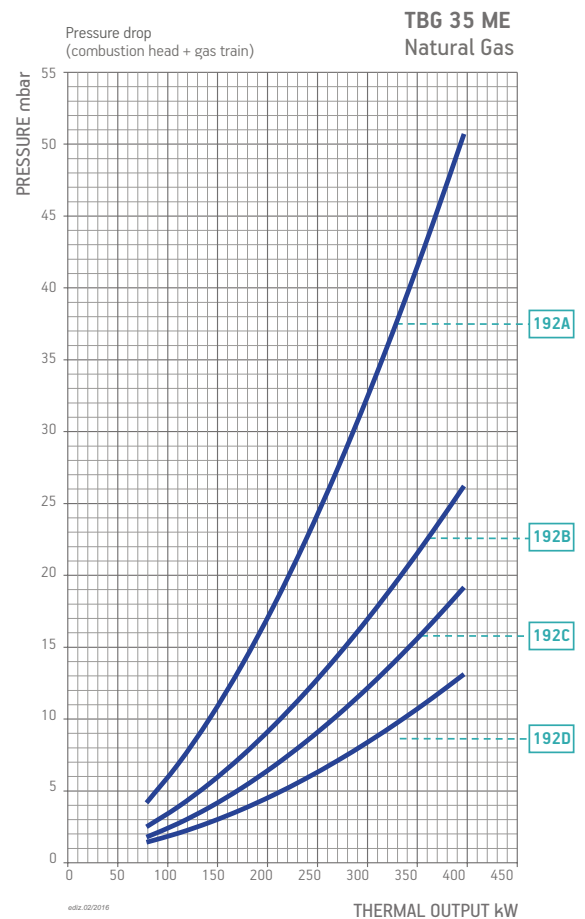
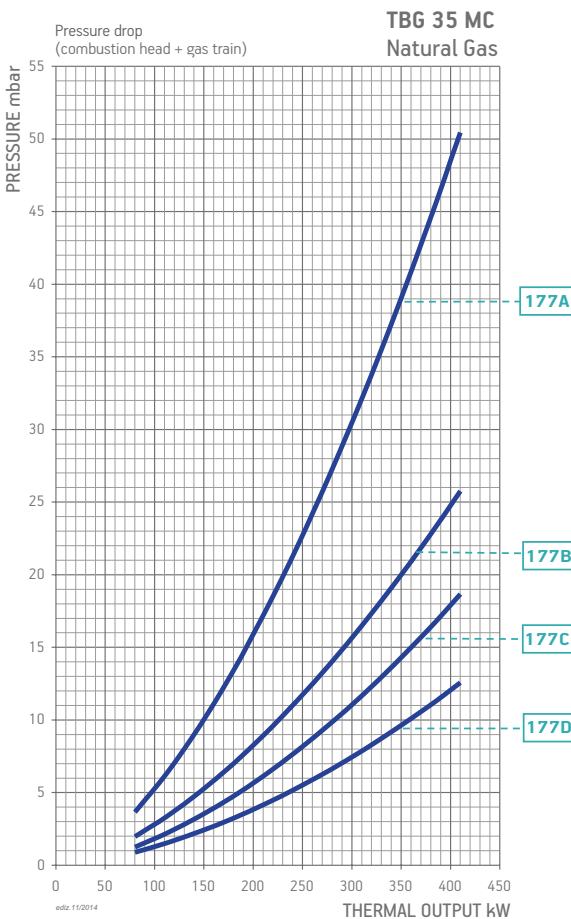
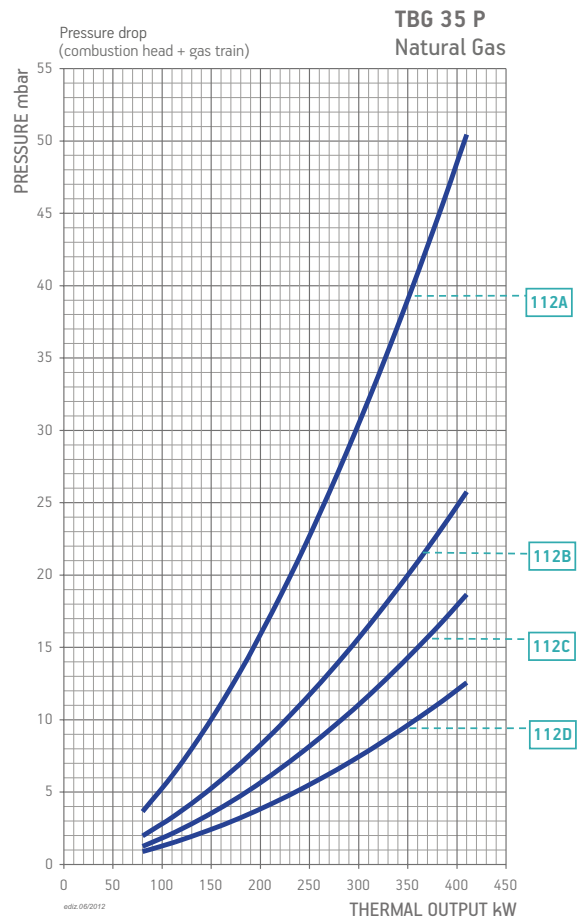
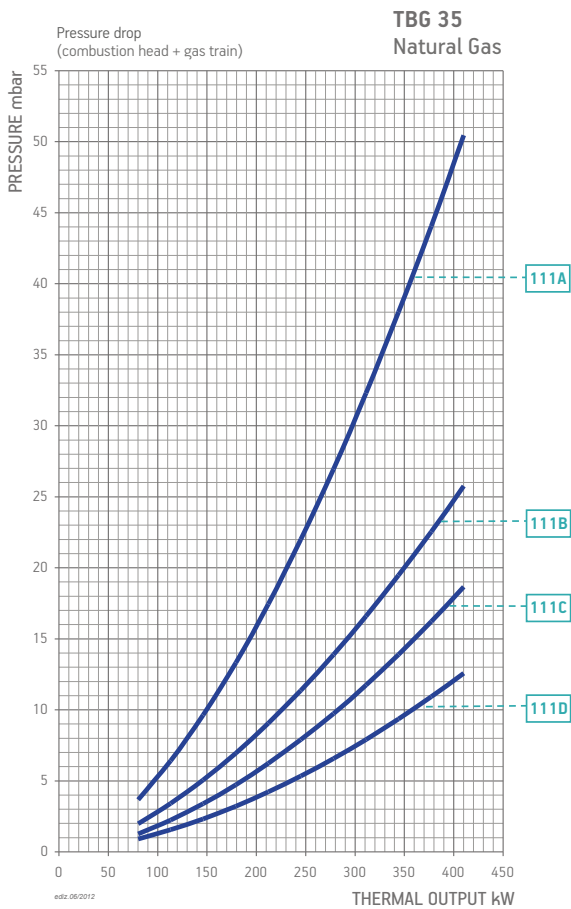

BURNER/GAS TRAIN MATCH

Burner model	Gas type	Curve on graph	Version	P.Max **	Execution	Gas train	Regulator with incorporated filter	Burner/gas train adapter	Valve tightness control kit	Pic.	Note
						Part no.	Part no.	Part no.	Part no.		
TBG 35	Natural gas	111A	CE/EXP	360	CTV	19990545	Included	96000005	-	M2	
						19990545	Included	96000005	98000100	M2	12)
		111B	CE/EXP	360	CTV	19990546	Included	96000004	-	M2	
						19990546	Included	96000004	98000100	M2	12)
		111C	CE/EXP	360	CTV	19990547	Included	96000004	-	M2	
19990547	Included					96000004	98000100	M2	12)		
111D	CE/EXP	360	CTV	19990548	Included	-	-	M2			
TBG 35 P	Natural gas	112A	CE/EXP	360	CTV	19990545	Included	96000005	-	BE7	
						19990545	Included	96000005	98000100	BE7	12)
		112B	CE/EXP	360	CTV	19990546	Included	96000004	-	BE7	
						19990546	Included	96000004	98000100	BE7	12)
		112C	CE/EXP	360	CTV	19990547	Included	96000004	-	BE7	
19990547	Included					96000004	98000100	BE7	12)		
112D	CE/EXP	360	CTV	19990548	Included	-	-	BE7			
TBG 35 MC	Natural gas	177A	CE/EXP	360	CTV	19990545	Included	96000005	-	BE7	
						19990545	Included	96000005	98000101	BE7	12)
		177B	CE/EXP	360	CTV	19990546	Included	96000004	-	BE7	
						19990546	Included	96000004	98000101	BE7	12)
		177C	CE/EXP	360	CTV	19990547	Included	96000004	-	BE7	
19990547	Included					96000004	98000101	BE7	12)		
177D	CE/EXP	360	CTV	19990548	Included	-	-	BE7			
TBG 35 ME	Natural gas	192A	CE/EXP	360	CTV	19990555	Included	96000005	Included	D2	
		192B	CE/EXP	360	CTV	19990556	Included	96000004	Included	D2	
		192C	CE/EXP	360	CTV	19990557	Included	96000004	Included	D2	
		192D	CE/EXP	360	CTV	19990558	Included	-	Included	D2	

Burner model	Gas type	Version	P.Max **	Execution	Gas train	Regulator with incorporated filter	Burner/gas train adapter	Valve tightness control kit	LPG kit	Pic.	Note
					Part no.	Part no.	Part no.	Part no.	Part no.		
TBG 35	LPG	CE/EXP	360	CTV	19990545	Included	96000005	-	-	M2	
					19990545	Included	96000005	98000100	-	M2	12)
TBG 35 P	LPG	CE/EXP	360	CTV	19990545	Included	96000005	-	-	B7	
					19990545	Included	96000005	98000100	-	B7	12)
TBG 35 MC	LPG	CE/EXP	360	CTV	19990545	Included	96000005	-	-	B7	
					19990545	Included	96000005	98000101	-	B7	12)
TBG 35 ME	LPG	CE/EXP	360	CTV	19990555	Included	96000005	Included	-	D2	

To choose the correct gas train please refer to the information on page 17 Burners Catalogue.
For information on the structure, composition, and size of the gas train please refer to the diagrams on page 12.

NOTE

- 12 Valve tightness control not required by EN676.
- CTV Gas train with Valve Tightness Control.
- ** Maximum gas inlet pressure at pressure regulator.

MODULATION

The two stage progressive burners, by installing the PID load controller and related modulating kit, can operate as modulating burners with the ability to adjust the thermic load according to boiler needs. The load adjustment is possible between the minimum and maximum burner's operating point.

How to choose the modulating kit components:

According to the parameter that it's necessary to control: temperature (°C) or pressure (bar) it's necessary to choose the range kit according to boiler operating range.

In case the value is included in two ranges it's necessary to select the lower range.

Example:

In case the required hot water boiler set point is 100°C it's necessary to select the temperature probe kit with operating range between 0 ÷ 130°C.

In case the steam boiler must operate with 8bar outlet steam pressure it's necessary to select the pressure probe kit with operating range between 0 ÷ 10 bar.



Automatic proportional modulation regulator PID

Part no.	Kit	Burners
98000055	Modulation kit LC3	TBG 450 ÷ 2000 MC
98000056	Modulation kit LC3	TBG 35 MC
98000057	Modulation kit LC3	TBML 80 ÷ 360 MC
98000058	Modulation kit LC3	TBG 45 ÷ 60 MC
98000059	Modulation kit LCM 100	ME models
98000065	Modulation kit LC4	TBG 80 ÷ 360 MC

Temperature probe for LC3 modulation

Part no.	Temperature	Type robe	Probe length	Male coupling
98000023	0 °C ÷ 130 °C	PT 1000	85 ¹⁾	R 1/2"
98000021	0 °C ÷ 500 °C	PT 1000	200 ¹⁾	G 1/2"
98000022	0 °C ÷ 1100 °C	Thermocouple	425 ¹⁾	R 1/2"



Temperature probe for LCM 100 modulation

Part no.	Temperature	Type robe	Probe length	Male coupling
98000023	0 °C ÷ 130 °C	PT 1000	85 ¹⁾	R 1/2"
98000021	0 °C ÷ 500 °C	PT 1000	200 ¹⁾	G 1/2"

Temperature probe for ETAMATIC OEM control box

Part no.	Temperature	Type robe	Probe length	Male coupling
98000035	0 °C ÷ 500 °C	PT 100	100 ¹⁾	G 1/2"



Steam pressure probe (for all types of automatic regulator)*

Part no.	Pressure steam	Signal output	Male coupling
98000045	0 ÷ 1 bar	4 ÷ 20 mA	G 1/2"
98000046	0 ÷ 10 bar	4 ÷ 20 mA	G 1/2"
98000047	0 ÷ 16 bar	4 ÷ 20 mA	G 1/2"
98000048	0 ÷ 25 bar	4 ÷ 20 mA	G 1/2"
98000049	0 ÷ 40 bar	4 ÷ 20 mA	G 1/2"

*) In the case of using applications where temperatures exceed 90°C you need to match the kit codes: 98000062

NOTE: In combination with the LC4 modulation kit for MC models, a 12V power supply kit is mandatory.

98000482	12V power supply kit
----------	----------------------

External climate regulation

Part no.	Description	Temperature
85060070	Temperature probe PT100	-50 °C ÷ 90 °C
98000061	Interface module for LC3	

Power signal converter (TBG 45÷360 MC / LX MC)

Part no.	Description
98000063	Converter kit 0 ÷ 10 V / 4 ÷ 20 mA

UV safe kit

Part no.	Description
98000443	UV SAFE KIT TBG 80-360 FGR
98000444	UV SAFE KIT TBG 450-750 FGR
98000445	UV SAFE KIT TBG 800 FGR
98000446	UV SAFE KIT TBG 1200 FGR

Note: For different modulation values please contact our Technical Assistance Service.

1) Different lengths on request.

Gas pressure regulator with incorporated filter approved CE*

Control closing , pressure taps upstream side - the side valley , safety diaphragm.
Max inlet pressure : 1 bar.

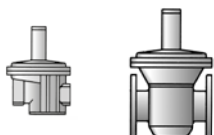

Part no.	Model	Outlet pressure mbar	Gas connection
97392010	BTFR/1	40 ÷ 110	1/2"
97392020	BTFR/1	40 ÷ 110	3/4"
97392030	BTFR/1	40 ÷ 110	1"
97392040	BTFR/1	90 ÷ 190	1"1/4
97392050	BTFR/1	90 ÷ 190	1"1/2
97392060	BTFR/1	90 ÷ 190	2"
97392070	BTFR/1	110 ÷ 200	DN65 - PN16
97392080	BTFR/1	110 ÷ 200	DN80 - PN16
97392090	BTFR/1	130 ÷ 200	DN100 - PN16

CE gas pressure regulator CE*

Control closing , pressure taps upstream side - the side valley , safety diaphragm.
Max inlet pressure : 1 bar.

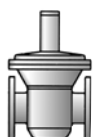

Part no.	Model	Outlet pressure mbar	Gas connection
97392100	BTR/1	100 ÷ 250	DN125 - PN16
97392110	BTR/1	100 ÷ 250	DN150 - PN16

Gas pressure regulator with incorporated filter approved CE*

Control closing , pressure taps upstream side - the side valley , safety diaphragm.
Max inlet pressure : 2 bar.

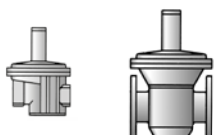

Part no.	Model	Outlet pressure mbar	Gas connection
97392210	BTFR/2	40 ÷ 110	1/2"
97392220	BTFR/2	40 ÷ 110	3/4"
97392230	BTFR/2	40 ÷ 110	1"
97392240	BTFR/2	90 ÷ 190	1"1/4
97392250	BTFR/2	90 ÷ 190	1"1/2
97392260	BTFR/2	90 ÷ 190	2"
97392270	BTFR/2	110 ÷ 200	DN65 - PN16
97392280	BTFR/2	110 ÷ 200	DN80 - PN16
97392290	BTFR/2	130 ÷ 200	DN100 - PN16

Gas pressure regulator with incorporated filter approved CE*

Control closing , pressure taps upstream side - the side valley , safety diaphragm.
Max inlet pressure : 6 bar.



Part no.	Model	Outlet pressure mbar	Gas connection
97392310	BTFR/6	30 ÷ 90	1/2"
97392320	BTFR/6	30 ÷ 90	3/4"
97392330	BTFR/6	30 ÷ 90	1"

CE gas pressure regulator CE*

Control closing , pressure taps upstream side - the side valley , safety diaphragm.
Max inlet pressure : 6 bar.

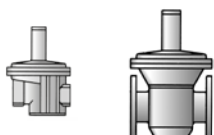

Part no.	Model	Outlet pressure mbar	Gas connection
97392340	BTR/6	85 ÷ 180	1"1/4
97392350	BTR/6	85 ÷ 180	1"1/2
97392360	BTR/6	85 ÷ 180	2"
97392370	BTR/6	110 ÷ 200	DN65 - PN16
97392380	BTR/6	110 ÷ 200	DN80 - PN16
97392390	BTR/6	110 ÷ 200	DN100 - PN16

*) All the pressure regulators in these pages have a standard spring with its own adjustment field. For different delivery pressures, the table below shows the regulation field that must be used, as well as the corresponding spring to replace the standard one with.

ACCESSORIES FOR CONNECTION OF BURNERS TO GAS MAINS

PRESSURE REGULATOR SPRINGS

		1/2"	3/4"	1"	1"1/4	1"1/2	2"	DN 65	DN 80	DN 100	DN 125	DN 150							
PRESSURE INPUT 1bar	regulator code	97392010	97392020	97392030	97392040	97392050	97392060	97392070	97392080	97392090	97392100	97392110							
	code spring	97399002	97399005	97399007	97399008	97399009	97399010	97399011	97399012	97399013	97399014	97399015	97399016	97399017	97399018	97399019	97399020	97399021	97399022
		9 ÷ 28	9 ÷ 28	9 ÷ 28															
		18 ÷ 40	18 ÷ 40	18 ÷ 40															
					13 ÷ 23	13 ÷ 23	13 ÷ 23												
		40 ÷ 110*	40 ÷ 110*	40 ÷ 110*															
					20 ÷ 36	20 ÷ 36	20 ÷ 36												
		110 ÷ 150	110 ÷ 150	110 ÷ 150															
		150 ÷ 200	150 ÷ 200	150 ÷ 200	33 ÷ 58	33 ÷ 58	33 ÷ 58												
					55 ÷ 100	55 ÷ 100	55 ÷ 100												
									13 ÷ 27	13 ÷ 27	15 ÷ 27								
									22 ÷ 50	22 ÷ 50	22 ÷ 55								
		200 ÷ 600	200 ÷ 600	200 ÷ 600															
					90 ÷ 190*	90 ÷ 190*	90 ÷ 190*												
									50 ÷ 130	50 ÷ 130	55 ÷ 130								
								110 ÷ 200*	110 ÷ 200*	130 ÷ 200*									
											20 ÷ 150	20 ÷ 150							
											100 ÷ 250*	100 ÷ 250*							
											230 ÷ 350	230 ÷ 350							
											300 ÷ 450	300 ÷ 450							
PRESSURE INPUT 2 bar	regulator code	97392210	97392220	97392230	97392240	97392250	97392260	97392270	97392280	97392290									
	code spring	97399001	97399005	97399008	97399010	97399011	97399012	97399013	97399014	97399015	97399016	97399017	97399018						
		9 ÷ 22	9 ÷ 22	9 ÷ 22															
		20 ÷ 40	20 ÷ 40	20 ÷ 40															
		40 ÷ 110*	40 ÷ 110*	40 ÷ 110*	12 ÷ 35	12 ÷ 35	12 ÷ 35												
		110 ÷ 150	110 ÷ 150	110 ÷ 150	30 ÷ 50	30 ÷ 50	30 ÷ 50												
		150 ÷ 200	150 ÷ 200	150 ÷ 200	40 ÷ 60	40 ÷ 60	40 ÷ 60												
					60 ÷ 95	60 ÷ 95	60 ÷ 95												
									13 ÷ 27	13 ÷ 27	15 ÷ 27								
									22 ÷ 50	22 ÷ 50	27 ÷ 55								
	200 ÷ 600	200 ÷ 600	200 ÷ 600																
				90 ÷ 190*	90 ÷ 190*	90 ÷ 190*													
								50 ÷ 130	50 ÷ 130	55 ÷ 130									
								110 ÷ 200*	110 ÷ 200*	130 ÷ 200*									
PRESSURE INPUT 6 bar	regulator code	97392310	97392320	97392330	97392340	97382350	97392360	97392370	97392380	97392390									
	code spring	97399003	97399004	97399006	97399009	97399011	97399012	97399013	97399014	97399016	97399017	97399018							
		20 ÷ 30	20 ÷ 30	20 ÷ 30															
		30 ÷ 90*	30 ÷ 90*	30 ÷ 90*															
		90 ÷ 170	90 ÷ 170	90 ÷ 170															
					15 ÷ 33	15 ÷ 33	15 ÷ 33												
					32 ÷ 60	32 ÷ 60	32 ÷ 60												
					50 ÷ 95	50 ÷ 95	50 ÷ 95												
									13 ÷ 27	13 ÷ 27	13 ÷ 22								
									22 ÷ 58	22 ÷ 58	18 ÷ 40								
				85 ÷ 180*	85 ÷ 180*	85 ÷ 180*													
								50 ÷ 130	50 ÷ 130	25 ÷ 120									
								110 ÷ 200*	110 ÷ 200*	110 ÷ 200*									

*) of series.

ACCESSORIES FOR CONNECTION OF BURNERS TO GAS MAINS

Gas filters approved CE

With pressure.

Max inlet pressure: 2 bar.



Part no.	Model	Gas connection
97410001	BTF	1/2" FF
97410002	BTF	3/4" FF
97410003	BTF	1" FF
97410004	BTF	1"1/4 FF
97410005	BTF	1"1/2 FF
97410006	BTF	2" FF
97419999	BTF	DN65 - PN16
97429999	BTF	DN80 - PN16
97439999	BTF	DN100 - PN16
97459999	BTF	DN125 - PN16
97449999	BTF	DN150 - PN16

Gas filters approved CE

With pressure.

Max inlet pressure: 6 bar.



Part no.	Model	Gas connection
97410010	BTF/6	1" 1/4" FF
97410011	BTF/6	1" 1/2" FF
97410012	BTF/6	2" FF
97410013	BTF/6	DN65 - PN16
97410014	BTF/6	DN80 - PN16
97410015	BTF/6	DN100 - PN16

Anti-vibration and compensation joints approved CE

DIN 30681 stainless steel.



Part no.	Model	Gas connection
97029999	BTGA	1/2" MM
97039999	BTGA	3/4" MM
97049999	BTGA	1" MM
97059999	BTGA	1" 1/4" MM
97069999	BTGA	1" 1/2" MM
97079999	BTGA	2" MM
97089999	BTGA	DN65 - PN16
97099999	BTGA	DN80 - PN16
97109999	BTGA	DN100 - PN16
97119999	BTGA	DN125 - PN16
97129999	BTGA	DN150 - PN16

Ball valves approved CE



Part no.	Model	Gas connection
97679999	BTVS	3/8" FF
97689999	BTVS	1/2" FF
97699999	BTVS	3/4" FF
97709999	BTVS	1" FF
97719999	BTVS	1" 1/4" FF
97729999	BTVS	1" 1/2" FF
97739999	BTVS	2" FF
97749999	BTVS	DN65 - PN16
97759999	BTVS	DN80 - PN16
97769999	BTVS	DN100 - PN16
97179999	BTVS	DN125 - PN16
97189999	BTVS	DN150 - PN16

SOUNDPROOF BURNER

Average sound pressure reduction of about 10 dB(A) measured in a laboratory with 1 meter microphone from the burner.

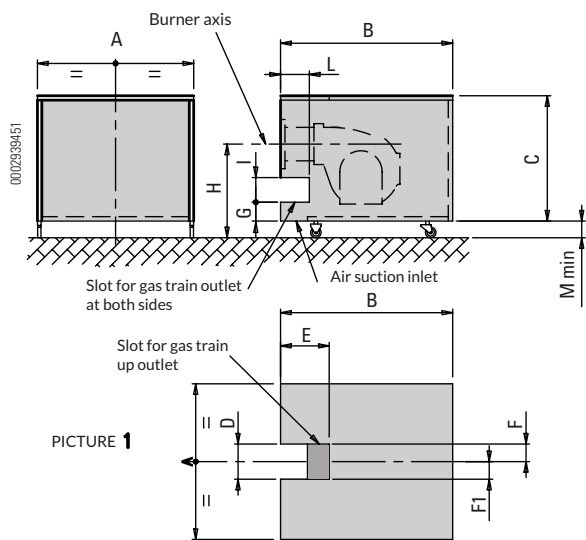

PICTURE 1

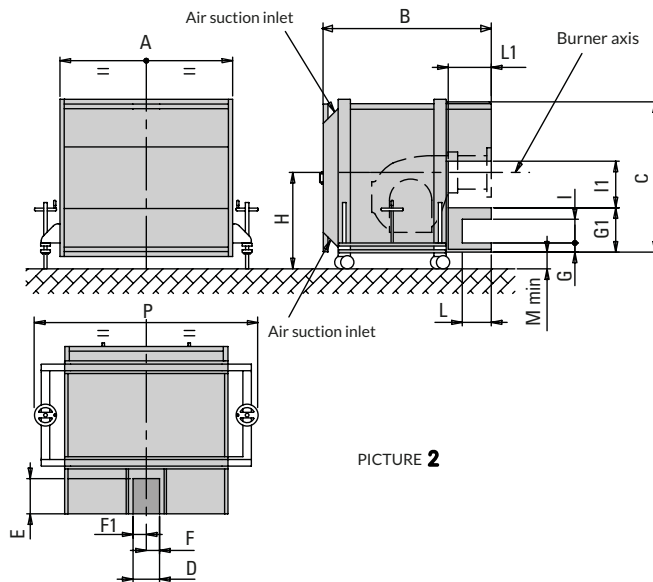

PICTURE 2

Model	Sound pressure	Pic.	A	B	C	D	E	F	F1	G	G1	H mm		I	I1	L	L1	M min	P
			mm	mm	mm	mm	mm	mm	mm	mm	mm	mm	mm	min	max	mm	mm	mm	mm
97980053*	-10 dB(A)	1	1100	1340	860	85	500	42,5	42,5	207	-	660	1350	85	-	500	-	190	-
97980054	-10 dB(A)	1	750	1080	650	85	380	42,5	42,5	157	-	560	1060	85	-	355	-	190	-
97980055	-10 dB(A)	1	1100	1340	860	85	440	42,5	42,5	-	-	650	1300	-	-	-	-	190	-
97980057	-10 dB(A)	1	1335	1655	1130	210	495	47,5	162,5	-	-	900	1700	-	-	-	-	190	-
97980058*	-10 dB(A)	1	1610	1740	1190	500	380	37,5	462,5	24,5	-	950	1700	210	-	380	-	190	-
97980059	-20 dB(A)	1	1560	1645	1190	500	380	37,5	462,5	245	-	950	1700	210	-	380	-	190	-
97980061	-20 dB(A)	2	1956	1945	1740	300	400	150	150	104	504	1450	1700	270	530	330	490	180	2540
97980063	-20 dB(A)	2	2180	1950	1830	350	410	175	175	85	480	1400	1200	310	580	345	505	195	2765

Note:

For gas burners in case of gas train up outlet it is necessary to install a 200 mm long cilindric extension.

*) To decrease the sound pressure by 20 dB(A) please contact our sales office.

ATTENTION:

It's customer responsibility to check the correct matching of soundproof according to the height of the boiler.

GAS TRAIN STRUCTURE AND COMPOSITION

B7

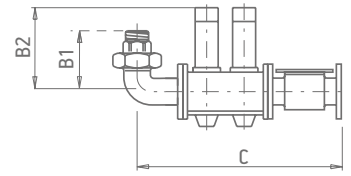
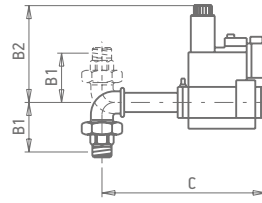
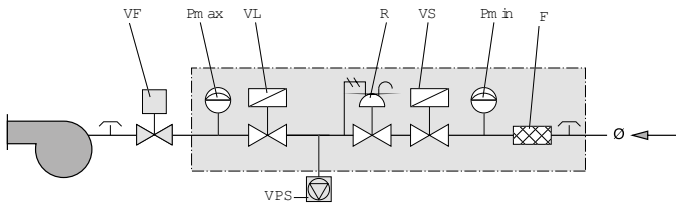

Pic. 1

Pic. 2

Gas train Part no.	Position								Gas train dimensions mm			Size of packaging mm L x P x H	Weight kg	Pic..	
	F	Pmax	Pmin	R	VF	VL	VPS	VS	Ø	B1	B2				C
19990712 (MB...412)	●	●	●	●	◆	●	▲	●	1"1/4	107	160	490	400x300x280	8	1
19990713 (MB...415)	●	●	●	●	◆	●	▲	●	1"1/2	115	170	595	460X250X460	11	1
19990714 (MB...415)	●	●	●	●	◆	●	▲	●	1"1/2	115	170	595	460X250X460	11	1
19990715 (MB...420)	●	●	●	●	◆	●	▲	●	2"	128	217	600	460X250X460	13	1
19990716 (MB...420)	●	●	●	●	◆	●	●	●	2"	128	217	600	460X250X460	13	1
19990717 (VGD20.503)	●	●	●	●	◆	●	●	●	2"	100	280	880	990X300X500	15	2
19990718 (VGD40.065)	●	●	●	●	◆	●	●	●	DN65	100	305	1120	1380X430X700	26	2
19990719 (VGD40.080)	●	●	●	●	◆	●	●	●	DN80	100	315	1190	1380X430X700	28	2

M2

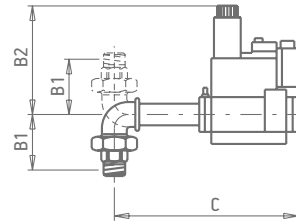
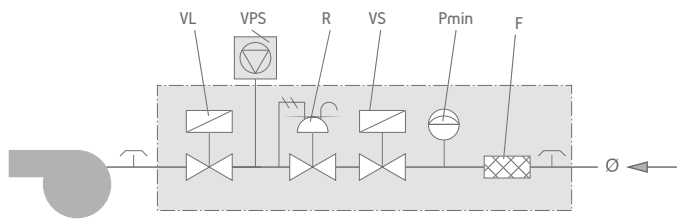

Gas train Part no.	Position							Gas train dimensions mm			Size of packaging mm L x P x H	Weight kg
	F	Pmin	R	VL	VPS	VS	Ø	B1	B2	C		
19990002 (MB... 405)	●	●	●	●	■	●	3/4"	72	140	204	310 x 210 x 250	4
19990005 (MB... 407)	●	●	●	●	■	●	3/4"	72	140	204	310 x 210 x 250	4
19990008 (MB... 410)	●	●	●	●	■	●	1"1/4	95	160	249	310 x 210 x 250	7
19990166 (MB... 412)	●	●	●	●	■	●	1"1/4	95	160	249	310 x 210 x 250	7
19990466 (MBC... 65)	●	●	●	●	●	●	1/2"	67	150	198	240 x 220 x 210	2
19990545 (MB... 407)	●	●	●	●	■	●	3/4"	72	140	450	300 x 210 x 300	5
19990546 (MB... 410)	●	●	●	●	■	●	1"1/4	95	160	490	400 x 300 x 280	8
19990547 (MB... 412)	●	●	●	●	■	●	1"1/4	95	160	490	400 x 300 x 280	8
19990548 (MB... 415)	●	●	●	●	■	●	1"1/2	103	270	600	460 x 250 x 460	11
19990549 (MB... 420)	●	●	●	●	■	●	2"	114	330	600	650 x 500 x 380	13
19990789 (MB... 405)	●	●	●	●	■	●	3/4"	72	140	450	300 x 210 x 300	5

CTV Valve tightness control.
F Filter.
LDU LDU valve tightness control.
Pct Pressure switch for gas control.
Pmax Maximum pressure switch.
Pmc Minimum and control pressure switch gas leaks.
Pmin Minimum pressure switch.
R Pressure regulator.
RF Pressure regulator with filter.

RFP Pressure regulator with filter for pilot gas train.
RM Manual flow rate regulator.
RP Pneumatic regulator.
VF Regulator throttle valve.
VL Operating valve.
VL2 Two-stage operating valve.
VLP Operating pilot valve.
VLR Operating valve with pressure regulator.

VP Pilot valve.
VPS VPS valve tightness control.
VS Safety valve.
VSP Safety pilot valve.
Ø Gas train diameter.
Ø1 Main gas train diameter.
Ø2 Pilot gas train diameter.

● As Standard.
 ▲ As standard for burners with an output of more than 1200 kW, on request for burners with an output of less than 1200 kW.
 ■ On request.
 ◆ Mounted on burner.

GAS TRAIN STRUCTURE AND COMPOSITION

BE7

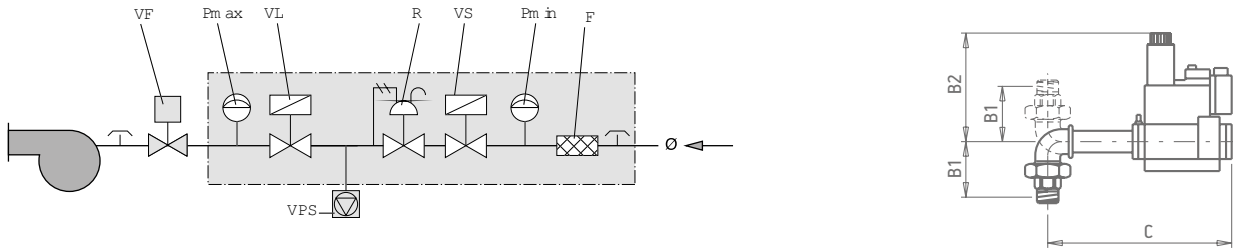

Gas train Part no.	Position								Gas train dimensions mm			Size of packaging mm	Weight
	F	Pmin	R	VF	VL	VPS	VS	Ø	B1	B2	C	L x P x H	kg
19990548 (MB...415)	●	●	●	◆	●	▲	●	1"1/2	103	170	600	460 x 250 x 460	11
19990549 (MB...420)	●	●	●	◆	●	▲	●	2"	114	220	600	460 x 250 x 460	13
19990550 (VGD20.503)	●	●	●	◆	●	▲	●	2"	114	285	890	990 x 300 x 500	15
19990563 (VGD40.065)	●	●	●	◆	●	▲	●	DN65	114	320	1120	1380 x 430 x 700	26
19990564 (VGD40.080)	●	●	●	◆	●	▲	●	DN80	114	325	1175	1380 x 430 x 700	28
19990545 (MB...407 - 3/4")	●	●	●	◆	●	■	●	3/4"	72	210	450	300 x 210 x 300	5
19990546 (MB...410 - 1")	●	●	●	◆	●	■	●	1"1/4	95	260	490	400 x 300 x 280	8
19990547 (MB...412 - 1"1/4)	●	●	●	◆	●	■	●	1"1/4	95	260	490	400 x 300 x 280	8

CTV Valve tightness control.
F Filter.
LDU LDU valve tightness control.
Pct Pressure switch for gas control.
Pmax Maximum pressure switch.
Pmc Minimum and control pressure switch gas leaks.
Pmin Minimum pressure switch.
R Pressure regulator.
RF Pressure regulator with filter.

RFP Pressure regulator with filter for pilot gas train.
RM Manual flow rate regulator.
RP Pneumatic regulator.
VF Regulator throttle valve.
VL Operating valve.
VL2 Two-stage operating valve.
VLP Operating pilot valve.
VLR Operating valve with pressure regulator.

VP Pilot valve.
VPS VPS valve tightness control.
VS Safety valve.
VSP Safety pilot valve.
Ø Gas train diameter.
Ø1 Main gas train diameter.
Ø2 Pilot gas train diameter.

● As Standard.
 ▲ As standard for burners with an output of more than 1200 kW, on request for burners with an output of less than 1200 kW.
 ■ On request.
 ◆ Mounted on burner.

GAS TRAIN STRUCTURE AND COMPOSITION

D2

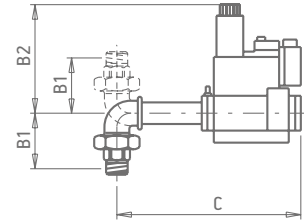
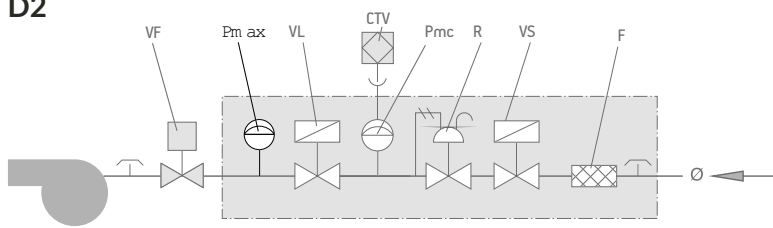

Gas train Part no.	Position									Gas train dimensions mm			Size of packaging mm	Weight
	CTV	F	Pmax	Pmc	R	VF	VL	VS	Ø	B1	B2	C	L x P x H	kg
19990524 (VGD20.503)	●	●		●	●	◆	●	●	2"	114	285	890	990 x 300 x 500	14
19990525 (VGD40.065)	●	●		●	●	◆	●	●	DN65	114	320	1120	1380 x 430 x 700	26
19990526 (VGD40.080)	●	●		●	●	◆	●	●	DN80	114	325	1175	1380 x 430 x 700	28
19990555 (MB... 407)	●	●		●	●	◆	●	●	3/4"	72	140	350	300 x 210 x 300	5
19990556 (MB... 410)	●	●		●	●	◆	●	●	1"1/4	95	160	390	300 x 210 x 300	8
19990557 (MB... 412)	●	●		●	●	◆	●	●	1"1/4	95	160	390	300 x 210 x 300	8
19990558 (MB... 415)	●	●		●	●	◆	●	●	1"1/2	103	170	490	460 x 250 x 460	11
19990559 (MB... 420)	●	●		●	●	◆	●	●	2"	114	220	520	520 x 410 x 410	13
19990561 (MB... 415)	●	●		●	●	◆	●	●	1"1/2	103	170	490	520 x 410 x 410	11
19990562 (MB... 420)	●	●		●	●	◆	●	●	2"	114	220	520	520 x 410 x 410	13
19990573 (MB... 407)	●	●		●	●	3/4"	●	●	3/4"	72	160	305	400 x 300 x 280	12
19990574 (MB... 410)	●	●		●	●	3/4"	●	●	1"1/4	95	160	355	400 x 300 x 280	15
19990575 (MB... 412)	●	●		●	●	3/4"	●	●	1"1/4	95	160	355	400 x 300 x 280	15
19990576 (MB... 415)	●	●		●	●	3/4"	●	●	1"1/2	103	170	445	520 x 410 x 410	18
19990577 (VGD40.065)	●	●		●	●	◆	●	●	DN65	125	320	760	1030 x 430 x 650	50
19990578 (VGD40.080)	●	●		●	●	◆	●	●	DN80	175	325	860	1030 x 430 x 650	57
19990748 (MB... 412)	●	●	●	●	●	◆	●	●	1"1/4	95	160	410	520 x 410 x 410	8
19990749 (MB... 415)	●	●	●	●	●	◆	●	●	1"1/2	103	170	500	520 x 410 x 410	11
19990750 (MB... 420)	●	●	●	●	●	◆	●	●	2"	114	220	500	520 x 410 x 410	13
19990754 (MB... 415)	●	●	●	●	●	◆	●	●	1"1/2	103	170	500	520 x 410 x 410	11
19990755 (MB... 420)	●	●	●	●	●	◆	●	●	2"	114	220	500	520 x 410 x 410	13

CTV Valve tightness control.
 F Filter.
 LDU LDU valve tightness control.
 Pct Pressure switch for gas control.
 Pmax Maximum pressure switch.
 Pmc Minimum and control pressure switch gas leaks.
 Pmin Minimum pressure switch.
 R Pressure regulator.
 RF Pressure regulator with filter.

RFP Pressure regulator with filter for pilot gas train.
 RM Manual flow rate regulator.
 RP Pneumatic regulator.
 VF Regulator throttle valve.
 VL Operating valve.
 VL2 Two-stage operating valve.
 VLP Operating pilot valve.
 VLR Operating valve with pressure regulator.

VP Pilot valve.
 VPS VPS valve tightness control.
 VS Safety valve.
 VSP Safety pilot valve.
 Ø Gas train diameter.
 Ø1 Main gas train diameter.
 Ø2 Pilot gas train diameter.

● As Standard.
 ▲ As standard for burners with an output of more than 1200 kW, on request for burners with an output of less than 1200 kW.
 ■ On request.
 ◆ Mounted on burner.



baltur **75** 
Energy for People
www.baltur.com
1950 - 2025

Baltur S.p.A.
Via Ferrarese, 10
44042 Cento (FE) - Italy
Tel. +39 051 684.37.11
info@baltur.it

Quality System Certified
UNI-EN ISO 9001 I.C.I.M. n° 202

The data given in this catalogue is to be deemed approximate and therefore not binding; Baltur reserves the right to make any changes without notice.